

# LED 고천장용 공장등

**GHLVL 80W | 100W | 120W | 150W**



- **국내 생산** 최신 LG이노텍 LED PKG 및 국내 KS인증 전원공급장치 적용
- **친환경 조명** 무수은, 친환경적인 LED조명 기구
- **에너지 절약** 높은 고효율 제품으로 에너지절감 효과 극대화
- **우수한 품질** 플리커 FREE로 깜빡임이 없으며 통신장비로 인한 오작동 없음
- 색온도: 5,700K / 수명시간: 50,000hrs / IP등급 : 65



※ 반사갓 (옵션, 별도구매)

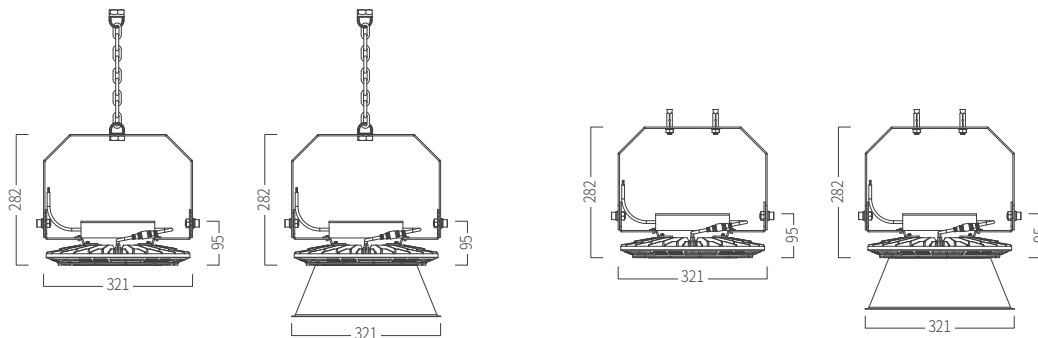

<Pendent Type>

<Bracket Type>

## HIGH BAY LIGHTING

GHLVL80W57K	
소비전력 (W)	80
총 광속 (lm)	10,400
조도 @1m (lx)	3,900
전압 (AC)	180~240
광효율 (lm/W)	130
역률 (PF)	>0.9
THD (%)	<20
연색성 (Ra)	>80
조사각 (°)	112/70
무게(kg)	3.4
구동 온도 (°C)	-20 ~ 45

\* 메탈램프 175~250W 대체

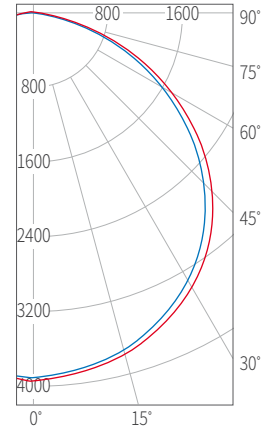
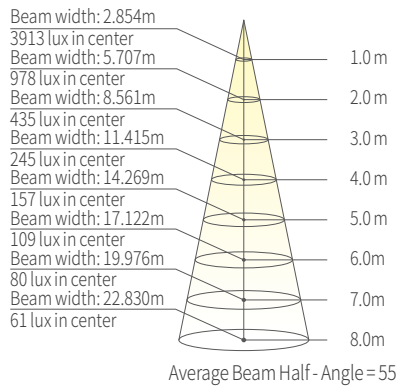

GHLVL100W57K	
소비전력 (W)	100
총 광속 (lm)	13,000
조도 @1m (lx)	4,900
전압 (AC)	180~240
광효율 (lm/W)	130
역률 (PF)	>0.9
THD (%)	<20
연색성 (Ra)	>80
조사각 (°)	112/70
무게(kg)	3.8
구동 온도 (°C)	-20 ~ 45

\* 메탈램프 250W 대체

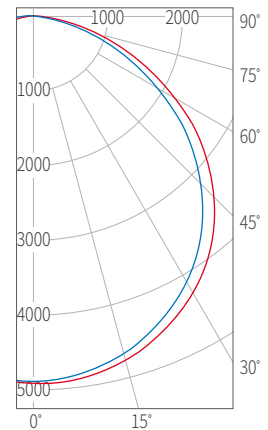
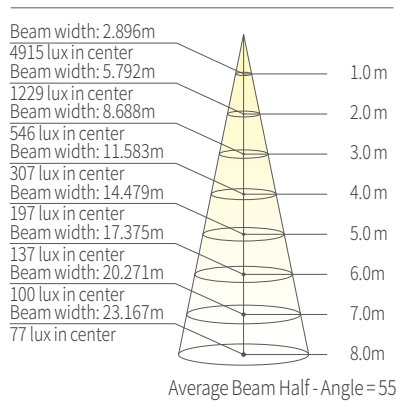

GHLVL120W57K	
소비전력 (W)	120
총 광속 (lm)	15,600
조도 @1m (lx)	6,000
전압 (AC)	180~240
광효율 (lm/W)	130
역률 (PF)	>0.9
THD (%)	<20
연색성 (Ra)	>80
조사각 (°)	112/70
무게(kg)	3.8
구동 온도 (°C)	-20 ~ 45

\* 메탈램프 350W 대체

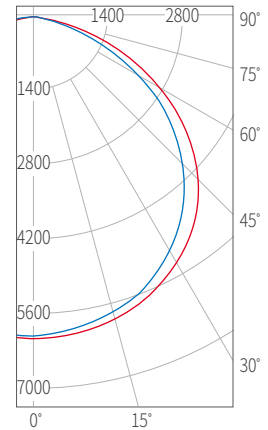
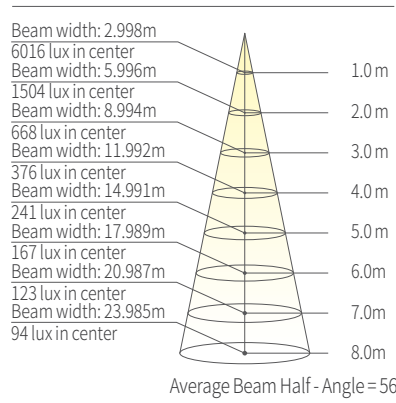

GHLVL150W57K	
소비전력 (W)	150
총 광속 (lm)	19,500
조도 @1m (lx)	7,300
전압 (AC)	180~240
광효율 (lm/W)	130
역률 (PF)	>0.9
THD (%)	<20
연색성 (Ra)	>80
조사각 (°)	112/70
무게(kg)	3.8
구동 온도 (°C)	-20 ~ 45

\* 메탈램프 400W 대체

